

HIOKI

3286-20

Instruction Manual

CLAMP ON POWER HiTESTER

EN

Apr. 2015 Revised edition 13
3286B981-13 15-04H



* 6 0 0 1 0 0 0 3 D *

Contents

Introduction	i
Shipping Check	ii
Safety	iii
Note on Use	vii
Organization of This Manual	xiii
Chapter 1 Product Outline	1
1.1 Product Outline	1
1.2 Features	2
1.3 Parts and Functions	3
1.4 Flowchart of Key Operations	9
1.4.1 Current Measurements Mode	9
1.4.2 Harmonic Measurement	11
1.4.3 Change the Range	11
Chapter 2 Measurement Procedure	13
2.1 Preparations	13
2.2 Connections	14
2.3 Range Setup	20
2.4 Power Measurement	21
2.4.1 1 ϕ P Meter, 1 ϕ PF Meter and 3 ϕ PF Meter	22
2.4.2 Power and Power Factor	25
2.4.3 Phase Detection	27
2.4.4 Current (Frequency)	28
2.4.5 Voltage (Frequency)	29
2.5 Harmonic Measurement	30
2.5.1 Current Harmonics	30
2.5.2 Voltage Harmonics	32
2.6 Data Hold Function HOLD	33

2.7	SLOW Mode	33
2.8	Recording Function REC	33
2.9	SETUP Function	35
2.10	Measurement Condition Save Function	36
2.11	Auto Power-Off Function APS	37
2.12	Battery Low Warning 	37
2.13	Beep Tone	37
Chapter 3 Specifications		39
3.1	Measurement Specifications	39
3.1.1	AC Current Measurement Specifications	39
3.1.2	AC Voltage Measurement Specifications	40
3.1.3	Specifications of Single-phase Power Measurement 1 ϕ P Meter	41
3.1.4	Specifications of Power Factor and Phase Angle Measurements 1 ϕ PF Meter and 3 ϕ PF Meter	42
3.1.5	Specifications of Balanced Three-phase Power Measurements	43
3.1.6	Specifications of Frequency Measurement	44
3.1.7	Specifications of Harmonic Measurement	44
3.2	General Specifications	45
3.3	Operation Expressions	49
Chapter 4 Battery Replacement		53
Chapter 5 Attaching The Hand Strap		55
Chapter 6 Storage in Carrying Case		57
Chapter 7 Troubleshooting		59
Chapter 8 Service		61

Introduction

Thank you for purchasing the HIOKI "3286-20 CLAMP ON POWER HiTESTER." To obtain maximum performance from the instrument, please read this manual first, and keep it handy for future reference.

Importance

This instrument is the clamp on power meter which keeps measurement function of the multiple functions. If you set up a function mode in advance, the mode will start up from the next use. Have it set up for the preferable use. (Refer to "2.10 Measurement Condition Save Function")

Request

We have tried to bring this manual as close to perfection as we could achieve. If perchance you find any unclear portions, mistakes, omissions, or the like, we would be most obliged if you could please notify us of them via any HIOKI agent, or directly.

Shipping Check

When you receive the instrument, inspect it carefully to ensure that no damage occurred during shipping. In particular, check the accessories, panel switches, key, and connectors.

If damage is evident, or if it fails to operate according to the specifications, contact your dealer or HIOKI representative.

Check the 3286-20 Unit and the Supplied Accessories

Main unit

3286-20 CLAMP ON POWER HiTESTER

Supplied accessories





9245 CARRYING CASE	1
L9635-01 VOLTAGE CORD	1
Hand Strap	1
Battery	1
Instruction manual	1

Safety











This instrument is designed to comply with IEC 61010 Safety Standards, and has been thoroughly tested for safety prior to shipment. However, mishandling during use could result in injury or death, as well as damage to the instrument. Be certain that you understand the instructions and precautions in the manual before use. We disclaim any responsibility for accidents or injuries not resulting directly from instrument defects.

The following symbols in this manual indicate the relative importance of cautions and warnings.

	Indicates that incorrect operation presents an extreme hazard that could result in serious injury or death to the user.
	Indicates that incorrect operation presents a significant hazard that could result in serious injury or death to the user.
	Indicates that incorrect operation presents a possibility of injury to the user or damage to the instrument.
	Indicates advisory items related to performance or correct operation of the instrument.

Safety Symbols

This manual contains information and warnings essential for safe operation of the instrument and for maintaining it in safe operating condition. Before using the instrument, be sure to carefully read the following safety notes.

	<ul style="list-style-type: none"> • The  symbol printed on the instrument indicates that the user should refer to a corresponding topic in the manual (marked with the  symbol) before using the relevant function. • In the manual, the  symbol indicates particularly important information that the user should read before using the instrument.
	Indicates AC (Alternating Current).
	Indicates DC (Direct Current).
	Indicates a double-insulated device.
	Indicates that the instrument may be connected to or disconnected from a live circuit.

We define measurement tolerances in terms of rdg. (reading) and dgt. (digit) values, with the following meanings:



rdg. (reading or displayed value)

The value currently being measured and indicated on the measuring instrument.

dgt. (resolution)

The smallest displayable unit on a digital measuring instrument, i.e., the input value that causes the digital display to show a "1".

Symbols for various standards

	<p>This symbol indicates that the product conforms to regulations set out by the EC Directive.</p>
	<p>Indicates the Waste Electrical and Electronic Equipment Directive (WEEE Directive) in EU member states.</p>

Measurement categories

This instrument complies with CAT III safety requirements.

To ensure safe operation of measurement instruments, IEC 61010 establishes safety standards for various electrical environments, categorized as CAT II to CAT IV, and called measurement categories. These are defined as follows.

- CAT II:** Primary electrical circuits in equipment connected to an AC electrical outlet by a power cord (portable tools, household appliances, etc.)
 CAT II covers directly measuring electrical outlet receptacles.
- CAT III:** Primary electrical circuits of heavy equipment (fixed installations) connected directly to the distribution panel, and feeders from the distribution panel to outlets.
- CAT IV:** he circuit from the service drop to the service entrance, and to the power meter and primary overcurrent protection device (distribution panel).

Using a measurement instrument in an environment designated with a higher-numbered category than that for which the instrument is rated could result in a severe accident, and must be carefully avoided. Use of a measurement instrument that is not CAT-rated in CAT II to CAT IV measurement applications could result in a severe accident, and must be carefully avoided.

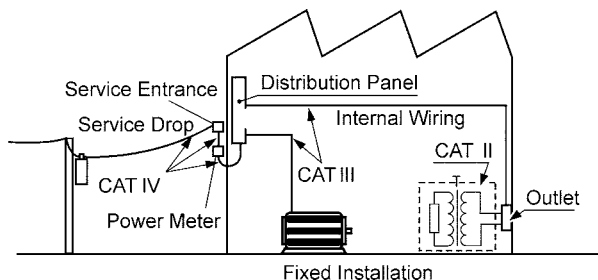



Note on Use

Follow these precautions to ensure safe operation and to obtain the full benefits of the various functions.

Preliminary Checks

- Before using the instrument the first time, verify that it operates normally to ensure that the no damage occurred during storage or shipping. If you find any damage, contact your dealer or Hioki representative.
- Before using the instrument, make sure that the insulation on the voltage cord is undamaged and that no bare conductors are improperly exposed. Using the product in such conditions could cause an electric shock, so contact your dealer or Hioki representative for replacements. (Model L9635-01)

**⚠ DANGER**

- To avoid short circuits and potentially life-threatening hazards, never attach the clamp sensor to a circuit that operates at more than **the maximum rated voltage to earth**.
- Clamp sensor should only be connected to the secondary side of a breaker, so the breaker can prevent an accident if a short circuit occurs. Connections should never be made to the primary side of a breaker, because unrestricted current flow could cause a serious accident if a short circuit occurs.
- Connect the voltage cords to the instrument first, and then to the active lines to be measured. Observe the following to avoid electric shock and short circuits.:
 - Do not allow the voltage cord clips to touch two wires at the same time.
 - Never touch the edge of the metal clips.
 - When the clamp sensor is opened, do not allow the metal part of the clamp to touch any exposed metal, or to short between two lines.

**⚠ WARNING**

- Do not allow the instrument to get wet, and do not take measurements with wet hands. This may cause an electric shock.
- To avoid electric shock when measuring live lines, wear appropriate protective gear, such as insulated rubber gloves, boots and a safety helmet.
- To avoid electric shock when replacing the battery, first disconnect the voltage cord or clamp from the object to be measured. After replacing the battery, replace the cover and screws before using the instrument.
- When replacing the battery, be sure to insert them with the correct polarity. Otherwise, poor performance or damage from battery leakage could result. Replace battery only with the specified type.
- Battery may explode if mistreated. Do not short-circuit, recharge, disassemble or dispose of in fire.
- Handle and dispose of batteries in accordance with local regulations.

**CAUTION**

- Avoid stepping on or pinching the cable, which could damage the cable insulation.
- Keep the cables well away from heat sources, as bare conductors could be exposed if the insulation melts.
- To prevent an electric shock accident, confirm that the white or red portion (insulation layer) inside the cable is not exposed. If a color inside the cable is exposed, do not use the cable.
- Do not exceed the maximum input current rating, which depends on the frequency of the current being measured. Be careful about the evolution of heat, when the input frequency is high.

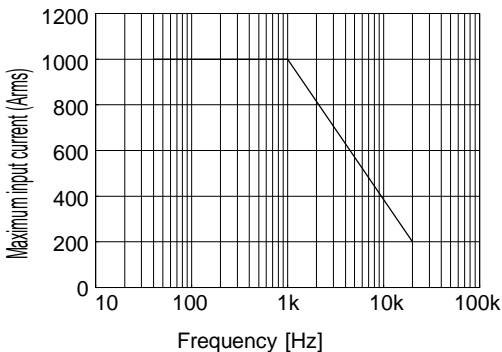

**⚠ CAUTION**

- If the protective functions of the instrument are damaged, either remove it from service or mark it clearly so that others do not use it inadvertently.
- Do not store or use the instrument where it could be exposed to direct sunlight, high temperature or humidity, or condensation. Under such conditions, the instrument may be damaged and insulation may deteriorate so that it no longer meets specifications.
- Keep the clamp jaws and core slits free from foreign objects, which could interfere with clamping action.
- To avoid damage to the instrument, protect it from physical shock when transporting and handling. Be especially careful to avoid physical shock from dropping. Do not exert excessive pressure on the clamp sensor or attempt to wedge the sensor into a tight spot for measurement.
- This instrument is designed for use indoors. It can be operated at temperatures between 0°C and 40°C without degrading safety.
- This instrument is not designed to be entirely water- or dust-proof. Do not use it in an especially dusty environment, nor where it might be splashed with liquid. This may cause damage.
- Calibration and repair of this instrument should be performed only under the supervision of qualified technicians knowledgeable about the dangers involved.

**NOTE**

- The **B** indicator appears when battery voltage becomes low. During which time accuracy cannot be guaranteed. Replace batteries only with the specified type.
- When replacing the battery, make sure that the metal battery snap fitting is firmly connected. If the metal fitting is loose, adjust it and recheck the connection.
- To avoid corrosion from battery leakage, remove the batteries from the instrument if it is to be stored for a long time.
- Correct measurement may be impossible in the presence of strong magnetic fields, such as near transformers and high-current conductors, or in the presence of strong electromagnetic fields such as near radio transmitters.

Organization of This Manual

Chapter 1

Product Outline

Explains the parts and functions of the instrument.

Chapter 2

Measurement Procedure

Explains how to use the 3286-20 for measurement.

Chapter 3

Specifications

Lists the specifications of the 3286-20 CLAMP ON AC/DC HiTESTER.

Chapter 4

Battery Replacement

Explains how to replace the battery used to power the 3286-20.

Chapter 5

Attaching the Hand Strap

Explains how to attach the hand strap, for easy handling of the instrument in the field.

Chapter 6

Storage in Carrying Case

Explains how to store the instruments in the carrying case.

Chapter 7

Troubleshooting

Describes how to check before requesting service.

Chapter 8

Service

Explains how to get the instrument serviced.

Chapter 1

Product Outline

1.1 Product Outline

The "3286-20 CLAMP ON POWER HiTESTER" is designed to provide multiple functions by adopting a single-chip microcomputer. At any desired point of a single-phase circuit or three-phase circuit, this instrument enables the measurement of voltage, current, power, power factor, phase angle, reactive power or frequency, and the detection of phase sequence on live lines.

1.2 Features

- **A multi-function microcomputer**
The built-in microcomputer offers various functions in a compact form.
- **Display of true rms values**
The true rms value conversion circuit allows accurate measurement of currents with distorted waveforms.
- **Enables power measurement**
When both current and voltage are input simultaneously, the power factor, phase angle, reactive factor, as well as power can be measured, and phase detected.
- **Enables harmonic measurement**
Higher harmonics of current and voltage up to the 20th order can be measured. Moreover, overall harmonic distortion factors and content can be displayed.

1.3 Parts and Functions

Top and Side View

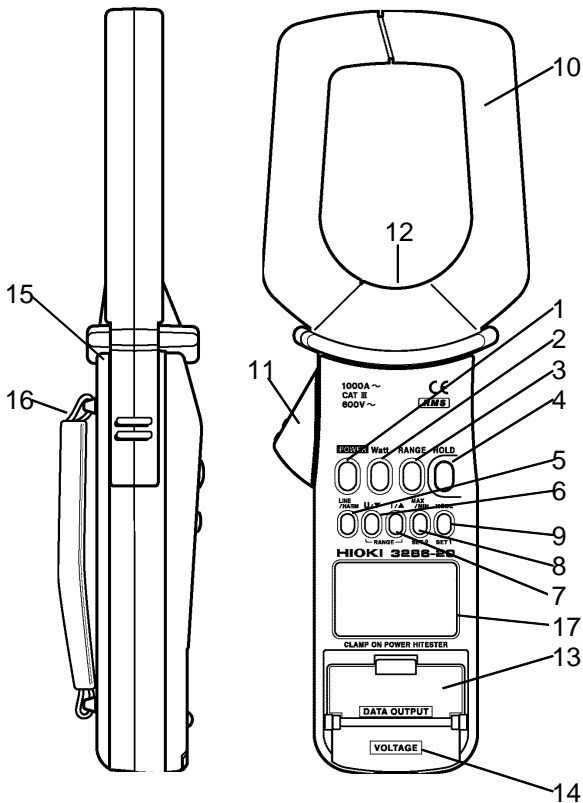

1. POWER

- Used to turn power on/off

2. Watt key

- Used to select the display of active power, apparent power, or power factor for the 1 ϕ P meter.
- Used to select the display of power factor, phase difference, or reactive factor for the 1 ϕ PF meter.
- Used to select the display of active power, apparent power, power factor, phase difference, or reactive factor for the 3 ϕ PF meter.

3. RANGE key

- Displays the current and voltage ranges, and enables the setting of these ranges. (The **U/▼** and **I/▲** keys are used to set these ranges.)

4. HOLD key

- Holds the indicated value.
- Used for the measurement condition save function.

Holding down the **HOLD** key when powering off:

The measurement conditions are saved to the internal memory when powering off. The measurement conditions are automatically restored when powering on.

Holding down the **HOLD** key when powering on:

Measurement conditions are reset to the initial values.

5. LINE/HARM key

- Cycles through single-phase power measurement, three-phase power measurement, current harmonic measurement, and voltage harmonic measurement.

-
6. **U/▼** (RANGE) key
 - Selects voltage display mode. Pressing this key in voltage display mode resets the peak-hold value.
 - Switches MAX/MIN display of effective value and peak value during REC.
 - Enables the setting of a voltage range in range setup mode.
 - Lowers the order in harmonic display mode.
 7. **I/▲** (RANGE) key
 - Selects current display mode. Pressing this key in current display mode resets the peak-hold value.
 - Switches MAX/MIN display of effective value and peak value during REC.
 - Enables the setting of a current range in range setup mode.
 - Raises the order in harmonic display mode.
 8. **MAX/MIN** (SET2) key
 - Switches the REC function on and off.
 9. **MODE** (SET1) key
 - Pressing this key in power display mode switches between current/voltage display and reactive power display.
 - Pressing this key during harmonic measurement switches between overall harmonic distortion factor display (THD-R, THD-F) and harmonic content display.
 - Pressing this key during REC lets you to check the elapsed time and remaining battery capacity.
 - Used to start **SETUP**. (The instrument is powered on with the **SET1** key held down.)
-

10. Clamp sensor

- To measure current, open the top ends of the clamp sensor by gripping the lever 11. Then position the conductor to be measured at the center of the clamp sensor and firmly close the clamp sensor.

11. Lever

- Used to open and close the clamp sensor.

12. Current direction mark

When measuring power, clamp the conductor with the arrow facing the load side.

*13. Data Output terminal

Connected to the optional 9636 RS-232C CABLE to provide output.

14. Voltage measurement terminal

Connected to the L9635-01 VOLTAGE CORD (red and black, supplied with the instrument) to measure voltage and harmonic.

15. Back case

To replace the battery, remove the two screws.

16. Hand strap

Attach to get a better grip on the instrument.

*: The Data Output function is only available for customers who have the Model 9636 RS-232C Cable, Model 9636-01 RS-232C Package.

Model 9636 and 9636-01 will be discontinued effective January 25, 2012

17. Display (LCD)

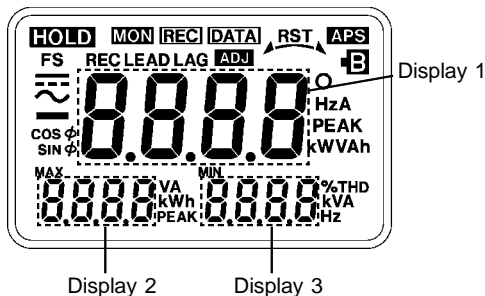

~	Alternating Current (AC)
cosϕ	Power factor
sinϕ	Reactive factor
HOLD	Data hold function
* DATA	Data output
RST	Three-Phase
↶	Reverse phase
↷	Normal phase
—	Missing phase
APS	Auto power off function
S	Slow
REC	Record function
LEAD	Lead phase
LAG	Lag phase
⊖	Battery low warning
○	Phase angle (deg.)
A	Current
PEAK	Wave peak value

W	Active power
VA	Apparent power
V	Voltage
MAX	Maximum value
MIN	Minimum value
%	Harmonic percentage
%THD	Total harmonic distortion ratio
Hz	Frequency
μAr	var (reactive power)
$HDIF$	Total harmonic distortion ratio-F (A distortion rate against the basic wave.)
$HDIR$	Total harmonic distortion ratio-R (A distortion rate toward the actual effective value.)

*: The Data Output function is only available for customers who have the Model 9636 RS-232C Cable, Model 9636-01 RS-232C Package.
Model 9636 and 9636-01 will be discontinued effective January 25, 2012

1.4 Flowchart of Key Operations

1.4.1 Current Measurements Mode

A point of view: This shows the way of changing on Display 1 to 3.

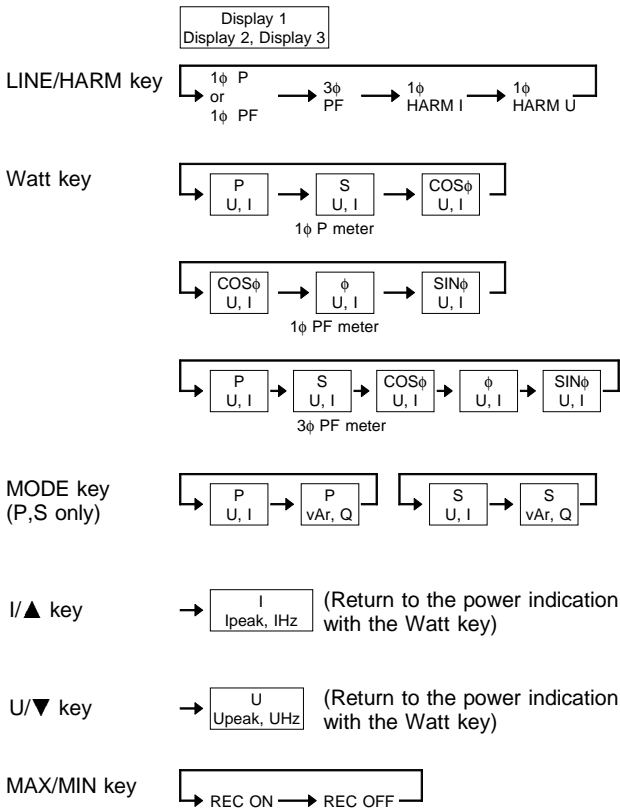

REC ON

Watt key

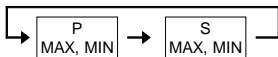

I/▲ key



(Return to the power indication with the Watt key)

U/▼ key

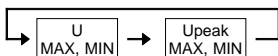

(Return to the power indication with the Watt key)

MODE key

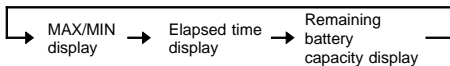

1.4.2 Harmonic Measurement

LINE/HARM key

MODE key

I/▲ key

U/▼ key

1.4.3 Change the Range

RANGE key

RANGE indication

I/▲ key

U/▼ key

Chapter 2

Measurement Procedure

2.1 Preparations

1. Remove the back case and insert a battery. (Refer to "Chapter 4 Battery Replacement".)
2. Press **POWER** to turn the instrument on. Verify that all segments of the display light up briefly. The model name then appears on Display 1 and battery state on Display 3.

б А Е Е 100

Fresh battery

б А Е Е 50

Battery capacity 50%

б А Е Е 0

Battery capacity 0 **B**

Beep tone sounds 3 times

3. The measuring state of the 1 ϕ P meter or 1 ϕ PF meter is activated. (The instrument was shipped from the factory with the 1 ϕ P meter selected. For details, see 2.9, "SETUP Function.")

[Low battery voltage detection function]

After the **B** mark lights and battery voltage drops below a certain level, the power goes off automatically. When this occurs, "б А Е Е L" is displayed.

When power goes off after display of these marks, replace the exhausted battery with a new one.

[To initialize the saved contents]

Holding down the **RANGE** key when powering on initializes all the saved contents. (SETUP Function, measurement condition save Function)

2.2 Connections

Before conducting measurement, check the connections.

 **WARNING**

- **Due to the risk of electric shock, connect the yellow cord not used for measurement to the part to which the black cord connects to prevent the clip from accidentally touching anyone.**

NOTE

- Be sure to connect the voltage clip to the part bearing the exposure voltage.

[Single-Phase Two-Wire Circuit]

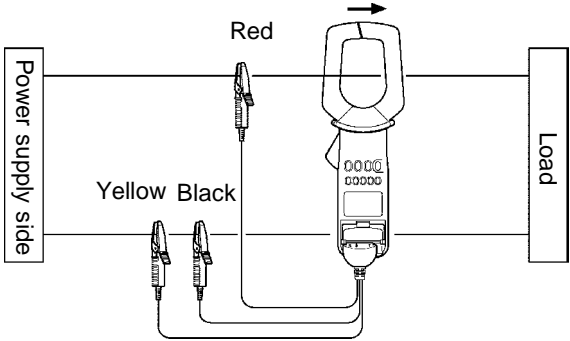

Figure 1.
Power Measurement on Single-Phase Two-Wire Circuit

[Single-Phase Three-Wire Circuit]

The power and power factor of a single-phase three-wire circuit are measured similar to measurement on a single-phase two-wire circuit. Connect the black cord to the neutral wire as shown in Figure 2, then switch the red cord and clamp sensor to the respective wires. In this way, the power and power factor between the wires can be measured.

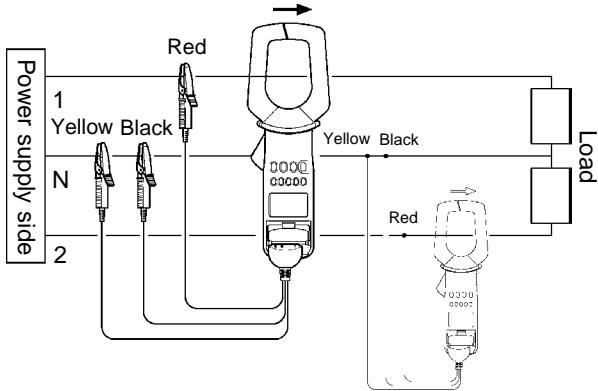

Figure 2. Power and power factor Measurement on Single-Phase Three-Wire Circuit

[Three-Phase Three-Wire Circuit]

Use another method of the power measurement of the figure 4 for the distortion wave.

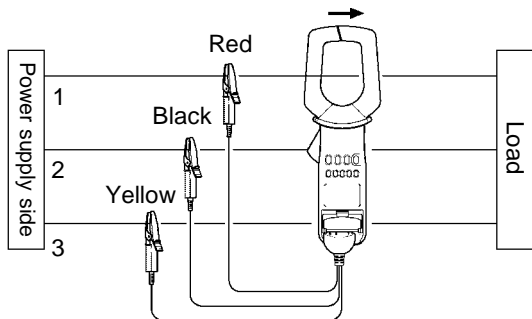

Figure 3. Power and power factor measurement on Three-Phase Three-Wire Circuit

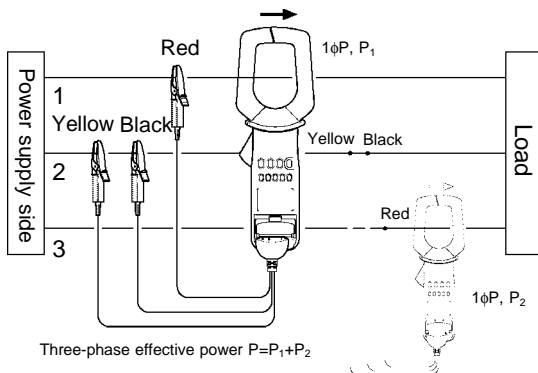

Figure 4. Another method of the power measurement on Three-Phase Three-Wire Circuit

[Three-Phase Four-Wire Circuit]

The power and power factor of a three-phase four-wire circuit are measured similar to measurement on a three-phase three-wire circuit (provided the load is balanced). No neutral wire is used for this measurement, however.

In case of unbalanced load, measurement is conducted similar to measurement on a single-phase two-wire circuit. Set the instrument in single-phase measurement mode.

Connect the black cord to the neutral wire as shown in Figure 5, then switch the red cord and clamp sensor to the respective wires. In this way, the power and power factor between the wires can be measured.

(To use the phase sequence detection function, connect the voltage cords to the three wires, excluding the neutral wire, for measurement.)

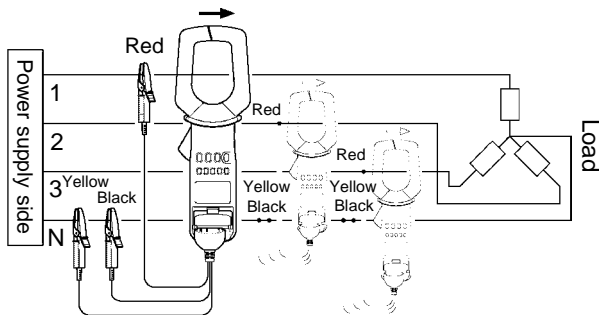

Figure 5. Power and power factor measurement on Three-Phase Four-Wire Circuit

[Current measurement]

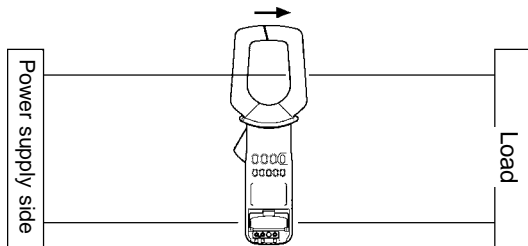

Figure 6. Current measurement

When only measuring current, the orientation of the clamp sensor is irrelevant. Moreover, the voltage cord need not be connected to the instrument.

[Voltage measurement]

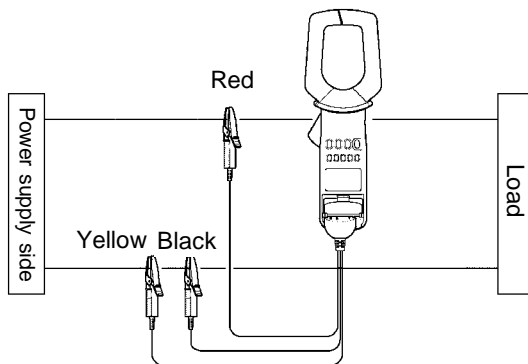

Figure 7. Voltage measurement

When only measuring voltage, the clamp sensor need not be clamped.

2.3 Range Setup

- Press the **RANGE** key. The voltage range then appears on Display 2 and current range on Display 3.
- In this condition, Display 2 and Display 3 should be blinking.



- To change the voltage range, press the **U/▼** key. To change the current range, press the **I/▲** key. The power range varies with the combination of voltage and current ranges as listed in Tables 1 and 2.

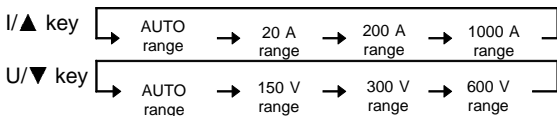

Table 1.
Range Composition for Single-Phase Power Measurement

		U		
		Voltage range		
		150.0 V	300.0 V	600 V
Current range	20.00 A	3.000 k	6.000 k	12.00 k
	200.0 A	30.00 k	60.00 k	120.0 k
	1000 A	150.0 k	300.0 k	600.0 k
Unit		[W] or [VA] or [var]		

Table 2.
Range Composition for Three-Phase Power Measurement

I \ U		Voltage range		
		150.0V	300.0V	600V
Current range	20.00A	6.000k	6.000k 12.00k	24.00k
	200.0A	60.00k	60.00k 120.0k	240.0k
	1000A	300.0k	600.0k	600.0k 1200k
Unit		[W] or [VA] or [var]		

- After changing the range, press the **RANGE** key. Display 2 and Display 3 then restore the measured values.

2.4 Power Measurement

NOTE

- Correct measurement may be impossible in the presence of strong magnetic fields, such as near transformers and high-current conductors, or in the presence of strong electromagnetic fields such as near radio transmitters.
- Make sure that only one conductor is clamped in the center of the clamp sensor. If you clamp single-phase (2-wire) or three-phase (3-wire) lines together, it will be impossible to measure.

2.4.1 1 ϕ P Meter, 1 ϕ PF Meter and 3 ϕ PF Meter

[1 ϕ P Meter]

Displays active power P once about every second (once about every three seconds in SLOW mode).

The meter calculates apparent power S , reactive power Q , and power factor $\cos \phi$ from active power P , voltage U , and current I . (See 3.3, "Operation Expressions.")

[1 ϕ PF Meter and 3 ϕ PF Meter]

The phase angle is measured at the zero-cross point of voltage U and current I as shown below. The meter calculates three-phase active power P , three-phase apparent power S , three-phase reactive power Q , and reactive factor $\sin \phi$, and power factor $\cos \phi$ from the phase angle ϕ , voltage U , and current I . (See 3.3, "Operation Expressions.")

For an inverter or thyristor with distorted input waveforms, or waveforms with noise superimposed, the meters may not display accurate values or even be able to measure at all.

Three-phase active power P is calculated on the 3 ϕ PF meter under balanced load conditions. Accurate measurements cannot be conducted under an unbalanced load.

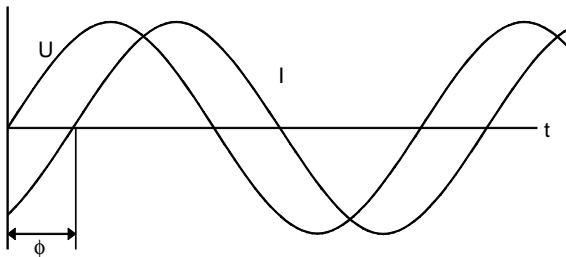





[Difference in λ between 1 ϕ P Meter and 1 ϕ PF Meter]

For distorted waveforms, the value of power factor λ may differ between the 1 ϕ P meter and 1 ϕ PF meter.

The difference is due to the fact that the 1 ϕ P meter calculates λ from active power and apparent power, while the 1 ϕ PF meter assumes a sine wave and calculates λ from the phase angles of the voltage waveform and current waveform of that sine wave. Therefore, phase-angle measurement serves as the basis for the 1 ϕ PF meter. Distorted waveforms and those with noise superimposed may prevent the meter from measuring power factors accurately or even at all. Therefore, use λ of the 1 ϕ P meter for distorted waveforms.

Sample Measurements

I	U	1 ϕ P Meter λ	1 ϕ PF Meter λ
		1.000	1.000
* 		0.847	0.750

* Distorted waveforms with crest factor of 1.9.

Power factor λ of the 3 ϕ PF meter is also obtained from the phase angles of voltage waveform and current waveform of an assumed sine wave.

Therefore, accurate measurements may also not be conducted with distorted waveforms or those with noise superimposed. The following example shows the measurement of power factor λ from power values on a three-phase circuit.

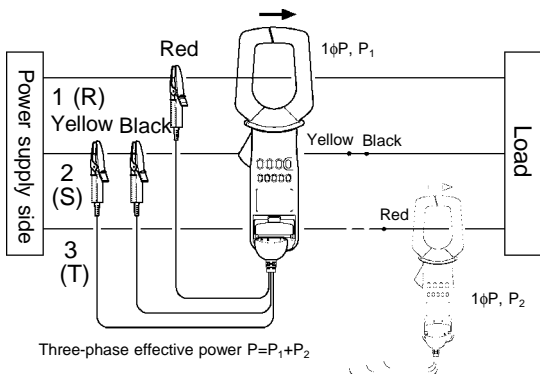

Measurement example

	P (1 ϕ P)	S (1 ϕ P)
R	-0.54 kW	2.61 kVA
T	1.98 kW	2.57 kVA

Three-phase effective power

$$P = P_1 + P_2 = -0.54 + 1.98 = 1.44 \text{ kW}$$

Three-phase apparent power

$$S = (\sqrt{3})/2 (2.61 + 2.57) = 4.49 \text{ kVA}$$

Power factor

$$\lambda = P/S = 1.44/4.49 = 0.321$$

Table 3. Items Displayed (Marked OK) and Not Displayed (-)

	1 ϕ P	1 ϕ PF	3 ϕ PF
Current I	OK	OK	OK
Voltage U	OK	OK	OK
Effective power P	OK	-	OK
Apparent power S	OK	-	OK
Reactive power Q	OK	-	OK
Power factor λ (COS ϕ)	OK	OK	OK
Phase angle ϕ	-	OK	OK
Reactive factor SIN ϕ	-	OK	OK

2.4.2 Power and Power Factor

WARNING

- Due to the risk of electric shock, connect the yellow cord not used for measurement to the part to which the black cord connects to prevent the clip from accidentally touching anyone.

1. Press the **LINE/HARM** key to select the 1 ϕ P meter, 1 ϕ PF meter, or 3 ϕ PF meter (RST goes on). (For switching between the 1 ϕ P meter and 1 ϕ PF meter, see 2.9, "SETUP Function.")

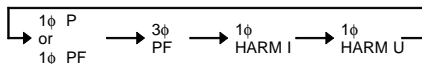

- Connect the voltage cord to the instrument, then connect the red cord, black cord, and yellow cord to the circuit under measurement according to prescribed connections. For a three-phase circuit, the instrument will display the results of phase detection as follows:

Normal phase $\overline{\text{RST}}$ ↗

Reverse phase ↖ $\overline{\text{RST}}$

Missing phase $\overline{\text{RST}}$

- Open the tip of the clamp core and clamp the conductor (on the side to which the red voltage cord is connected) roughly into the center of the clamp core, then conduct measurement. In this operation, clamp the conductor in such an orientation that the arrow mark on the clamp sensor surface points to the load side from the power supply side.
- Select active power, apparent power, power factor, phase angle, or reactive factor with the **Watt** key. Note that the 1 ϕ P meter does not display phase angle and reactive factor. The 1 ϕ PF meter does not display active power and apparent power.

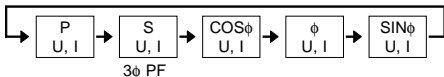
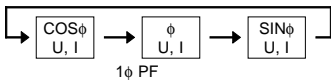
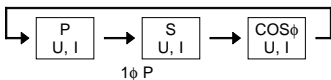

5. Pressing the **MODE** key in active power or apparent power display mode indicates reactive power. Pressing the **MODE** key again restores the current and voltage display.



6. Switch between Auto Range and Manual Range, as needed. For details, see 2.3, "Range Setup."

NOTE

- The 3 ϕ PF meter calculates P, Q and S under a balanced load.
- The 3 ϕ PF meter cannot provide accurate measurement results under an unbalanced load.
- For a missing phase, the instrument will not display any measured value. ("- - -") will be displayed.)
- If the arrow mark on the surface of the clamp sensor points to the power supply side from the load side, the phase will be shifted by 180 degrees, thus disabling measurement. ("- - -") will be displayed.)

2.4.3 Phase Detection

Press the **LINE/HARM** key to select the 3 ϕ PF meter (RST goes on). Before starting measurement, check the connections. (See 2.2, "Connections.")

In a three-phase measurement, the instrument will display phase detection results as follows:

Normal phase **RST** \blacktriangle
 Reverse phase \blacktriangle **RST**
 Missing phase **RST**

NOTE

- If a load is connected to the electrical line while a phase is missing on the power supply side, voltage coming back from the load to the tester may cause normal or reverse phase to be displayed even though a phase is missing.

2.4.4 Current (Frequency)

1. Press the **I/▲** key to activate current display mode. In current display mode, the instrument will indicate an effective value on Display 1, peak hold value on Display 2, and frequency on Display 3.
2. Switch between Auto Range and Manual Range, as needed. For details, see 2.3, "Range Setup."
3. Open the tip of the clamp core and clamp the conductor roughly into the center of the clamp core.
4. Pressing the **I/▲** key in current display mode resets the peak hold value.

NOTE

- Be sure to clamp one conductor only. Measurement is not possible for single phase or three phases when two or three conductors are respectively clamped at the same time.
- When only measuring current, there is no need to connect the voltage cord.
- Select the 1 ϕ P meter, 1 ϕ PF meter, or 3 ϕ PF meter.
- The instrument does not display polarities in a peak measurement.
- The peak hold value will not vary, unless a large value is entered in the instrument. If the auto power-off function is effective, the instrument will be shut down in about ten minutes, causing the data to be lost. (See 2.11, "Auto Power-Off Function.") One way to prevent data from being lost is to disable the auto power-off function (see 2.9, "SETUP Function") or to use the recording function.
- For measurement extending the auto power-off time, use the recording function.
- To check variations in a peak value, enable the REC function by pressing the **MAX/MIN** key, then activate peak value display mode by pressing the **I/▲** key.

NOTE

- Automatic frequency detection (AUTO), 50 Hz fixed, or 60 Hz fixed can be selected. In cases where the input fluctuates significantly, the indicated value will stabilize when 50 Hz or 60 Hz fixed is selected. For how to select, see the setup of measurement line frequency in SETUP mode. (For details, see 2.9, "SETUP Function.")
- There is a possibility to fluctuate 2 or 20 counts at the peak value display when the input becomes big.
- Some special frequencies can't be measured, such as those of inverters.

2.4.5 Voltage (Frequency)

1. Press the **U/▼** key to activate voltage display mode. In voltage display mode, an effective value appears on Display 1, peak-hold value on Display 2, and frequency on Display 3.
2. Connect the voltage cord to the instrument, then connect the red cord, yellow cord, and black cord to the circuit under measurement.
3. Switch between Auto Range and Manual Range, as needed. For details, see 2.3, "Range Setup."
4. Pressing the **U/▼** key in voltage display mode resets the peak-hold value.

NOTE

- Select the 1 ϕ P meter, 1 ϕ PF meter, or 3 ϕ PF meter.
- The instrument does not display polarities in a peak measurement.
- The peak hold value will not vary, unless a large value is entered in the instrument. If the auto power-off function is effective, the instrument will be shut down in about ten minutes, causing the data to be lost. (See 2.11, "Auto Power-Off Function.") One way to prevent data from being lost is to disable the auto power-off function (see 2.9, "SETUP Function") or to use the recording function.

NOTE

- For measurement extending the auto power-off time, use the recording function.
- To check variations in a peak value, enable the REC function by pressing the **MAX/MIN** key, then activate peak value display mode by pressing the **I/▲** key.
- Automatic frequency detection (AUTO), 50 Hz fixed, or 60 Hz fixed can be selected. In cases where the input fluctuates significantly, the indicated value will stabilize when 50 Hz or 60 Hz fixed is selected. For how to select, see the setup of measurement line frequency in SETUP mode. (For details, see 2.9, "SETUP Function.")
- There is a possibility to fluctuate 2 or 20 counts at the peak value display when the input becomes big.
- Some special frequencies can't be measured, such as those of inverters.

2.5 Harmonic Measurement

2.5.1 Current Harmonics

1. Press the **LINE/HARM** key to activate harmonic current display mode.

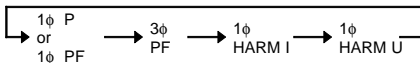

2. Switch between Auto Range and Manual Range, as needed. For details, see 2.3, "Range Setup."
3. Open the tip of the clamp core and clamp the conductor roughly into the center of the clamp core.
4. Press the **I/▲** and **U/▼** keys to select the order of harmonics to be measured.

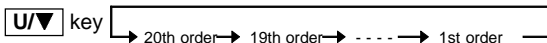
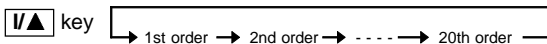

5. Switch between the total harmonic distortion ratio (THD-R, THD-F) and harmonic percentage from one to another, as needed, by pressing the **MODE** key.

**NOTE**

- Be sure to clamp one conductor only. Measurement is not possible for single phase or three phases when two or three conductors are respectively clamped at the same time.
- Automatic frequency detection (AUTO), 50 Hz fixed, or 60 Hz fixed can be selected. In cases where the input fluctuates significantly, the indicated value will stabilize when 50 Hz or 60 Hz fixed is selected. For how to select, see the setup of measurement line frequency in SETUP mode. (For details, see 2.9, "SETUP Function.")
- For automatic frequency detection, the instrument performs FFT operations only when the fundamental wave is covered within the 45 to 65 Hz range. The instrument does not perform FFT operations outside this range.

2.5.2 Voltage Harmonics

1. Press the **LINE/HARM** key to activate harmonic voltage display mode.

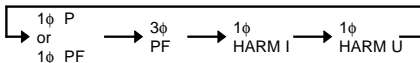

2. Connect the voltage cord to the instrument, then connect the red cord and black cord to the circuit under measurement.
3. Switch between Auto Range and Manual Range, as needed. For details, see 2.3, "Range Setup."
4. Press the **I/▲** and **U/▼** keys to select the order of harmonics to be measured.

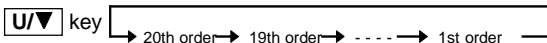
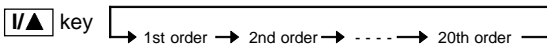

5. Switch between the total harmonic distortion ratio (THD-R, THD-F) and harmonic percentage, as needed, by pressing the **MODE** key.

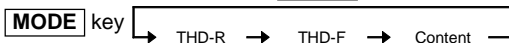

NOTE

- Automatic frequency detection (AUTO), 50 Hz fixed, or 60 Hz fixed can be selected. In cases where the input fluctuates significantly, the indicated value will stabilize when 50 Hz or 60 Hz fixed is selected. For how to select, see the setup of measurement line frequency in SETUP mode. (For details, see 2.9, "SETUP Function.")
- For automatic frequency detection, the instrument performs FFT operations only when the fundamental wave is covered within the 45 to 65 Hz range. The instrument does not perform FFT operations outside this range.

2.6 Data Hold Function **HOLD**

This function freezes the counter at any desired point for easy reading.

Press the **HOLD** key. **HOLD** annunciator lights on the display and the digital display value is maintained.

The data hold function is available for all measurements.

To cancel the data hold function, press the **HOLD** key again.

2.7 SLOW Mode

If an indicated value fluctuates rapidly and is difficult to read, you can select a slower display update rate (about once every three seconds) to make it easier to read the indicated value. Set SLOW display by setting DISP in SETUP mode. (See 2.9, "SETUP Function.")

NOTE

- SLOW mode is not available for harmonic measurements.
-

2.8 Recording Function **REC**

The recording function can be used to display the maximum value, the minimum value or the present measured value.

1. **REC** annunciator will blink when you press the **MAX/MIN** key during a current or a voltage measurement. This function will have stored the measured data in the internal memory since the key is pressed.
 2. The auto power-off function is automatically disabled. (**APS** annunciator is tuned off.)
-

3. Pressing the **MODE** key while using the recording function lets you check the elapsed time and remaining battery capacity.

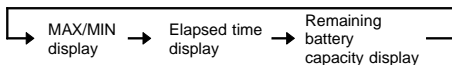

In elapsed time display, the instrument indicates hours on Display 2 and minutes on Display 3. When elapsed time is displayed with MAX or MIN blinking, a negative value is denoted.

4. The **HOLD** key will suspend the recording function. **HOLD** annunciator lights and **REC** annunciator stops blinking. While **HOLD** is shown, the elapsed time is not increasing. By pressing the **HOLD** key once more, **HOLD** annunciator is off and the recording function resumes.
5. To reset the recording data during the recording function, press the **MAX/MIN** key.
- NOTE** • When starting the recording function (**REC**) in an auto range, the range is set as the recording function is activated.

Items Displayed (Marked OK) and Not Displayed (-)

	1 ϕ P	1 ϕ PF	3 ϕ PF
Current I	OK	OK	OK
Current peak value I _{peak}	OK	OK	OK
Voltage U	OK	OK	OK
Voltage peak value U _{peak}	OK	OK	OK
Effective power P	OK	-	OK
Apparent power S	OK	-	OK

2.9 SETUP Function

The settings for this instrument are made in SETUP mode.

In SETUP mode, you can make settings for measurements, display, and ancillary functions.

1. Hold down the **SET1** key while powering on the instrument by pressing the **POWER** key. This activates SETUP mode.
2. Select a setting item. The **MODE** key increments the item No.; the **MAX/MIN** key decrements the item No.
3. The settings can be modified using the **U/▼** key or **I/▲** key.
4. Pressing the **HOLD** key twice in succession restores the initial values for the setting items.
5. At instrument power-off, "SRuE End" (SAVE END) appears and the settings are saved.

6. Details of Settings

Display 1 Item No.	Display 2 Item Name	Display 3 Setting	Initial Value
1-01	1P,PF	ON / OFF	OFF
1-02	FREQ	Auto / 50% / 60%	Auto
1-03	SAMP	Normal / Slow	Normal
1-04	AP5	ON / OFF	ON
1-05	bBEEP	ON / OFF	ON

(1) Setup of single-phase power meter system

Item No. 1-01 1P,PF

ON Sets 1 ϕ PF meter. ON

OFF Sets 1 ϕ P meter. OFF

- (2) Setup of measurement line frequency
Item No. 1-02 FREQ
AUTO Automatically detects measurement line frequency. \blacksquare \blacksquare
50 Hz Sets measurement line frequency to 50 Hz.
60 Hz Sets measurement line frequency to 60 Hz.
- (3) Setup of display update rate
Item No. 1-03 SAMP (SAMP)
NORM Sets display update to normal rate (1 s).
 \blacksquare \blacksquare \blacksquare (NORMAL)
SLOW Sets display update to SLOW (3 s). \blacksquare \blacksquare \blacksquare
(SLOW)
- (4) Setup of auto power-off function
Item No. 1-04 PPO
ON Enables the auto power-off function. \blacksquare \blacksquare
OFF Disables the auto power-off function. \blacksquare \blacksquare \blacksquare
- (5) Setup of buzzer function
Item No. 1-05 BEEP
ON Enables the buzzer function. \blacksquare \blacksquare
OFF Disables the buzzer function. \blacksquare \blacksquare \blacksquare

2.10 Measurement Condition Save Function

1. Hold down the **HOLD** key at instrument power-off.
The measurement conditions in effect at that point are saved.
2. The measurement conditions thus saved are the measurement line, power, harmonic display, current, and voltage ranges.

- To return the saved measurement conditions to their initial values, hold down the **HOLD** key at instrument power-on. After the entire LCD goes on, the instrument will display "dRtR cLr", and the saved contents of measurement conditions are returned to their initial values.

2.11 Auto Power-Off Function **APS**

When **APS** annunciator is displayed, the auto power-off function is active.

If no key is pressed for about 10 minutes, the instrument turns itself off automatically.

Immediately before turning off automatically, **APS** annunciator blinks and a beep tone is heard for about 30 seconds.

By pressing any key except **POWER**, you will extend the powered state for another 10 minutes.

To enable or disable the auto power-off function, set APS in SETUP mode. (See 2.9, "SETUP Function.")

Auto Power-Off function becomes ineffective while a REC function is used.

2.12 Battery Low Warning **B**

When this annunciator lights, the battery is exhausted and a correct measurement is not assured. Replace a new battery.

When the battery voltage drops below a certain level, the instrument indicates "bRtR L□" and is shut down.

2.13 Beep Tone

To enable or disable the audible buzzer when pressing a key, set BEEP in SETUP mode. (See 2.9, "SETUP Function.")

Chapter 3

Specifications

3.1 Measurement Specifications

Temperature and humidity for guaranteed accuracy	23°C±5°C(73°F±9°F), 80% RH or less (no condensation), battery warning indicator  is off.
Guaranteed accuracy period	1 year, or opening and closing of the Clamp Sensor 10000 times, whichever comes first

3.1.1 AC Current Measurement Specifications

Maximum permissible current	1000 Arms continuous
Effect of conductor position	within ±0.7% (in any position from sensor center)
External magnetic field interference	400 A/m AC (external magnetic fields corresponds to 1.00 A or less (display))
Maximum rated voltage to earth	max. 600 V rms

AC current (true rms) I_{RMS}

Range (Accuracy Range)	Resolution	Accuracy	
		45Hz to 66Hz	66Hz to 1kHz
20.00 A (1.00 A rms to 20.00 A rms)	0.01 A	±1.3%rdg. ±3dgt.	±2.0%rdg. ±5dgt.
200.0 A (10.0 A rms to 200.0 A rms)	0.1 A	±1.3%rdg. ±3dgt.	±2.0%rdg. ±5dgt.
1000A (100 A rms to 1000 A rms)	1 A	±1.3%rdg. ±3dgt.	±2.0%rdg. ±5dgt.

AC current (wave peak value) I_{PEAK}

Range (Accuracy Range)	Resolution	Accuracy
		45Hz to 1kHz
20.0 A (1.0 A rms to 20.0 A rms)	0.1 A	$\pm 3.0\%$ rdg. ± 5 dgt.
200 A (10.0 A rms to 200.0 A rms)	1 A	$\pm 3.0\%$ rdg. ± 5 dgt.
1000 A (100 A rms to 1000 A rms)	1 A	$\pm 3.0\%$ rdg. ± 5 dgt.

3.1.2 AC Voltage Measurement Specifications

AC voltage (true rms) U_{RMS}

Range (Accuracy Range)	Resolution	Accuracy	
		45Hz to 66Hz	30Hz to 45Hz, 66Hz to 1kHz
150.0 V (10.0 V rms to 150.0 V rms)	0.1 V	$\pm 1.0\%$ rdg. ± 3 dgt.	$\pm 1.5\%$ rdg. ± 5 dgt.
300.0 V (80.0 V rms to 300.0 V rms)	0.1 V	$\pm 1.0\%$ rdg. ± 3 dgt.	$\pm 1.5\%$ rdg. ± 5 dgt.
600 V (80 V rms to 600 V rms)	1 V	$\pm 1.0\%$ rdg. ± 3 dgt.	$\pm 1.5\%$ rdg. ± 5 dgt.

AC voltage (wave peak value) U_{PEAK}

Range (Accuracy Range)	Resolution	Accuracy
		30Hz to 1kHz
150 V (10.0 V rms to 150.0 V rms)	1 V	$\pm 3.0\%$ rdg. ± 5 dgt.
300 V (80.0 V rms to 300.0 V rms)	1 V	$\pm 3.0\%$ rdg. ± 5 dgt.
600 V (80 V rms to 600 V rms)	1 V	$\pm 3.0\%$ rdg. ± 5 dgt.

3.1.3 Specifications of Single-phase Power Measurement 1 ϕ P Meter

Measurement condition	Single phase, 50/60 Hz																								
Measurement range	Effective measurement current range: 1 A to 1000 A Effective measurement voltage range: 80 V to 600 V																								
Out of range	If either the current (line current) range or voltage (line voltage) range is out of range, power measurement will also be out of range.																								
Active power measurement	<table border="1"> <thead> <tr> <th colspan="2" rowspan="2"></th> <th colspan="3">Current Range</th> </tr> <tr> <th>20.00 A</th> <th>200.0 A</th> <th>1000 A</th> </tr> </thead> <tbody> <tr> <th rowspan="3">Voltage Range</th> <th>150.0 V</th> <td>3.000 kW</td> <td>30.00 kW</td> <td>150.0 kW</td> </tr> <tr> <th>300.0 V</th> <td>6.000 kW</td> <td>60.00 kW</td> <td>300.0 kW</td> </tr> <tr> <th>600 V</th> <td>12.00 kW</td> <td>120.0 kW</td> <td>600.0 kW</td> </tr> </tbody> </table>						Current Range			20.00 A	200.0 A	1000 A	Voltage Range	150.0 V	3.000 kW	30.00 kW	150.0 kW	300.0 V	6.000 kW	60.00 kW	300.0 kW	600 V	12.00 kW	120.0 kW	600.0 kW
		Current Range																							
		20.00 A	200.0 A	1000 A																					
Voltage Range	150.0 V	3.000 kW	30.00 kW	150.0 kW																					
	300.0 V	6.000 kW	60.00 kW	300.0 kW																					
	600 V	12.00 kW	120.0 kW	600.0 kW																					
Measurement accuracy	$\pm 2.3\% \text{rdg.} \pm 5 \text{dgt.} (\cos\phi=1)$																								
Apparent power S, reactive power measurement Q, power factor $\text{COS}\phi$																									
Method of measurement	Obtained by calculation from active power, current, and voltage measurements.																								
Measurement accuracy	$\pm 1 \text{ dgt.}$ with respect to calculation from each measured value.																								
Measurement range	[W] in the above table is replaced by [VA] or [var].																								

3.1.4 Specifications of Power Factor and Phase Angle Measurements 1 ϕ PF Meter and 3 ϕ PF Meter

Measurement conditions	Singe phase/balanced three phases, 50/60 Hz, sine wave
Measurement range	Effective measurement current range: 1 A to 1000 A Effective measurement voltage range: 80 V to 600 V

Phase angle measurement ϕ

Method of measurement	Obtained from phase detection circuit.
Measurement range	

Measurement Mode	Resolution	Measurement Range	Accuracy
ϕ	0.1°	LEAD 90° to 0 to LAG 90°	$\pm 3^\circ$

Power factor measurement λ

Method of measurement	Obtained by calculation from phase angles.
Measurement range	

Measurement Mode	Resolution	Measurement Range	Accuracy*
$\cos\phi$	0.001	LEAD 0 to 1 to LAG 0	$\pm 3^\circ \pm 2\text{dgt.}$

* Calculating error of ± 2 dgt. is added to phase angle measurement error.

Reactive factor measurement

Method of measurement	Obtained by calculation from phase angles.
Measurement range	

Measurement Mode	Resolution	Measurement Range	Accuracy*
$\sin\phi$	0.001	LEAD 0 to 1 to LAG 0	$\pm 3^\circ \pm 2\text{dgt.}$

* Calculating error of ± 2 dgt. is added to phase angle measurement error.

3.1.5 Specifications of Balanced Three-phase Power Measurements

Active and apparent power measurements

Measurement conditions	Balanced three phases, 50/60 Hz, sine wave
Method of measurement	Active power calculated from apparent power and phase angle information.
Measurement range (Active power P/Apparent power S)	

Voltage \ Current		Current (line current) Range		
		20.00 A	200.0 A	1000 A
Voltage (line voltage) Range	150.0 V	6.000 kW	60.00 kW	300.0 kW
	300.0 V	6.000 kW 12.00 kW	60.00 kW 120.0 kW	600.0 kW
	600 V	24.00 kW	240.0 kW	600.0 kW 1200 kW

For apparent power, [W] is replaced by [VA].

Measurement	$\pm 3.0\% \text{rdg.} \pm 10 \text{dgt.} (\cos\phi=1)$
Reactive power measurement Q	
Method of measurement	Obtained by calculation from active and apparent powers.
Measurement accuracy	$\pm 1 \text{ dgt.}$ with respect to calculation from each measured value.
Measurement range	The unit of [W] in the above table is replaced by [var].

3.1.6 Specifications of Frequency Measurement

Measurement ranges

(For current measurement/voltage measurement)

Range (Accuracy Range)	Resolution	Accuracy
100.0 Hz (30.0 Hz to 100.0 Hz)	0.1 Hz	$\pm 0.3\% \text{rdg.} \pm 1 \text{dgt.}$
1000 Hz (100 Hz to 1000 Hz)	1 Hz	$\pm 1.0\% \text{rdg.} \pm 1 \text{dgt.}$

Minimum input

Current: 1.00 A rms, Voltage: 10.0 V rms

3.1.7 Specifications of Harmonic Measurement

Measurement condition

Fundamental wave frequency: 50/60 Hz

Measurement function

AC current/AC voltage

Harmonic analysis

Window width

1 cycle (50/60 Hz)

Type of window

Rectangular

Number of analysis data

256 points

Order of analysis

1st order to 20th order

Analysis item

Harmonic level

Harmonic levels of current and voltage

Harmonic percentage

Harmonic percentage of current and voltage

Total harmonic distortion ratio

Total harmonic distortion ratio of current and voltage (THD-F and THD-R)

Measurement
accuracy
Harmonic levels

Order	Accuracy
1	$\pm 3.0\% \text{rdg.} \pm 10 \text{dgt.}$
2 to 6	$\pm 3.5\% \text{rdg.} \pm 10 \text{dgt.}$
7 to 8	$\pm 4.5\% \text{rdg.} \pm 10 \text{dgt.}$
9 to 10	$\pm 5.0\% \text{rdg.} \pm 10 \text{dgt.}$
11 to 15	$\pm 7.0\% \text{rdg.} \pm 10 \text{dgt.}$
16 to 20	$\pm 10\% \text{rdg.} \pm 10 \text{dgt.}$

Harmonic percentage	± 1 dgt. with respect to calculation from each measured value.
Total harmonic distortion ratio	± 1 dgt. with respect to calculation from each measured value.

3.2 General Specifications

Operating system Digital sampling system
Phase detection system

	Single-phase Power Measurement	Power Factor & Phase Angle Measurement
Waveform	Digital sampling	-
Phase	-	Phase detection

	Three-phase Power Measurement	Harmonic Measurement Function
Waveform	Digital sampling	Digital sampling
Phase	Phase detection	-

○ Accessory Functions:

Phase detection (at 3-phase balanced load) Normal/ Reverse/ Missing (50/60 Hz, sine wave)

Recording Maximum (MAX) and minimum (MIN) values display selectable for current, voltage, and effective / apparent power measurements

Data hold Data hold function

Auto power-off	Automatic shutdown after 10.5 ± 1 minutes. Beep tone warning before the shutdown. Extending and disabling possible.
Battery low voltage power-off	When the battery voltage falls below a certain level, the function shuts down the instrument to prevent malfunctions.
Beep tone	ON/OFF
○ Display	LCD panel
Digital counter	6000 counts max.
Over-range display	"O.L."
Data hold annunciator	HOLD
Auto power-off annunciator	APS
Battery low warning	⏻ goes on (during which time accuracy cannot be guaranteed).
Battery low voltage power-off	bAtt Lo (7 segments used) Power turned off after display.
Display update rate	Digital counter NORMAL $1s \pm 50$ ms (approx. 1 time/second) SLOW $3s \pm 0.15$ s (approx. 1 time/3 seconds) HARM meas. $2s \pm 0.1s$ (approx. 1 time/2 seconds)
Display response time	The range is fixed, 0% to 90%, 3.5 s max. Phase measurement, 4.0 s max.
Range switching	Auto range, manual (fixed) range (selectable). The power range depends on current and voltage ranges.
Circuit dynamic characteristics (crest factor)	2.5 max. (1.7 for 1000 A range and 600 V range)
Withstand voltage	Clamp sensor - Chassis, clamp sensor - circuit: 7060 Vrms AC for 1 minute.

Zero suppression	5 counts (for current and voltage measurement)
Location for use	Indoor, altitude up to 2000 m (6562 feet)
Applicable standards	Safety: EN 61010 Measurement categories III (expected transient overvoltage: 6000 V), Pollution level 2, EN 60529 IP40 (protected against access to hazardous parts with a wire) EMC: EN 61326
Maximum conductor diameter for measurement	ϕ 55 mm max. 80 x 20 mm bus bar
Operating temperature and humidity range	0 to 40°C (32 to 104°F), 80%RH or less (no condensation)
Temperature characteristics	
Current and voltage measurement	In 0 to 40°C range: 0.1 x accuracy specifications/°C
Phase detection circuit	In 0 to 40°C range: Within ± 2 deg.
Storage temperature range	-10 to 50°C (14 to 122°F, no condensation)
Power source	6LR61, 6LF22 alkaline battery 9V x 1
Maximum power consumption	220 mVA
Battery life	Alkaline battery (6LR61, 6LF22) approx. 25 hours Manganese battery (6F22) approx. 10 hours
External dimensions	Approx. 100W x 287H x 39D mm Approx. 3.94"W x 11.30"H x 1.54"D
Mass	Approx. 650 g (except for the battery) Approx. 22.9 oz. (except for the battery)

Accessories	9245 CARRYING CASE	1
	L9635-01 VOLTAGE CORD	1
	Hand Strap	1
	Battery	1
	Instruction manual	1

3.3 Operation Expressions

General operation expressions

Function	Item	Symbol	Operation Expression
Current measurement	Current (Effective value)	I [Arms]	$\sqrt{\frac{1}{M} \sum_{n=0}^{M-1} I_n^2}$
Voltage measurement	Voltage (Effective value)	U [Vrms]	$\sqrt{\frac{1}{M} \sum_{n=0}^{M-1} U_n^2}$
Single-phase power measurement 1 ϕ P meter	1 ϕ active power	P [W]	$\frac{1}{M} \sum_{n=0}^{M-1} U_n \cdot I_n$
	1 ϕ apparent power	S [VA]	$U \cdot I$
	1 ϕ reactive power	Q [var]	$\sqrt{S^2 - P^2}$
	1 ϕ power factor	λ	$\frac{P}{S}$
Single-phase power factor and phase angle measurements 1 ϕ PF meter (Sine wave, 50/60 Hz)	1 ϕ power factor	λ	$\cos\phi$
	1 ϕ reactive factor		$\sin\phi$

Function	Item	Symbol	Operation Expression
Balanced three-phase power factor, phase angle, and power measurements 3 ϕ PF meter (Balanced three phases, sine wave, 50/60 Hz)	3 ϕ power factor	$\lambda(3\phi)$	For line current I_R lags U_{RS} : $\cos \phi-30^\circ $ For line current I_R leads U_{RS} : $\cos (\phi +30^\circ)$
	3 ϕ reactive factor		For line current I_R lags U_{RS} : $\sin \phi-30^\circ $ For line current I_R leads U_{RS} : $\sin (\phi +30^\circ)$
	3 ϕ active power	$P(3\phi)$ [W]	$\sqrt{3} \cdot \lambda_{(3\phi)} \cdot S_{(1\phi)}$
	3 ϕ apparent power	$S(3\phi)$ [VA]	$\sqrt{3} \cdot S_{(1\phi)}$
	3 ϕ reactive power	$Q(3\phi)$ [var]	$\sqrt{S_{(3\phi)}^2 - P_{(3\phi)}^2}$
Remarks: M : Sampling number n : Sample point number ϕ : Phase difference between line voltage U_{RS} and line current I_R			

Harmonic operation expressions

Item		Symbol	Operation Expression
Harmonic current	Effective value	I_k [Arms]	$\sqrt{I_{kr}^2 + I_{ki}^2}$
	k-th harmonic content		$\frac{I_k}{I_1} \times 100$ (%)
	Overall harmonic distortion factor	THD-F [%]	$\frac{\sqrt{\sum_{k=2}^{20} I_k^2}}{I_1} \times 100$ (%)
		THD-R [%]	$\frac{\sqrt{\sum_{k=2}^{20} I_k^2}}{I} \times 100$ (%)
Harmonic voltage	Effective value	U_k [Vrms]	$\sqrt{U_{kr}^2 + U_{ki}^2}$
	k-th harmonic content		$\frac{U_k}{U_1} \times 100$ (%)
	Overall harmonic distortion factor	THD-F [%]	$\frac{\sqrt{\sum_{k=2}^{20} U_k^2}}{U_1} \times 100$ (%)
		THD-R [%]	$\frac{\sqrt{\sum_{k=2}^{20} U_k^2}}{U} \times 100$ (%)
Remarks: k: Harmonic order			

Chapter 4 Battery Replacement

⚠ WARNING

- To avoid electric shock when replacing the battery, first disconnect the voltage cord or clamp from the object to be measured. After replacing the battery, replace the cover and screws before using the instrument.
- When replacing the battery, be sure to insert them with the correct polarity. Otherwise, poor performance or damage from battery leakage could result. Replace battery only with the specified type.
- To avoid the possibility of explosion, do not short circuit, disassemble or incinerate batteries.
- Handle and dispose of batteries in accordance with local regulations.

⚠ CAUTION

Do not fix the back casing screws too tightly.
The torque about 0.5N·m is recommended.

NOTE

- The **B** indicator appears when battery voltage becomes low. During which time accuracy cannot be guaranteed. Replace batteries only with the specified type.
- When replacing the battery, make sure that the metal battery snap fitting is firmly connected. If the metal fitting is loose, adjust it and recheck the connection.
- To avoid corrosion from battery leakage, remove the batteries from the instrument if it is to be stored for a long time.

1. Remove the two fastening screws of the back case, using a Phillips screwdriver.
2. Remove the back case.
3. Remove the old battery without pulling the codes of the snap.
4. Securely connect the battery to the battery snap.
5. Replace the back case and tighten the fastening screws.

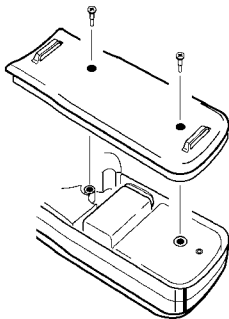

Chapter 5 Attaching The Hand Strap

Explains how to attach the hand strap, for easy handling of the instrument in the field.

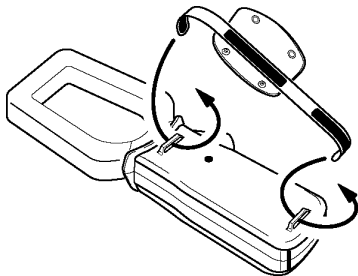

Chapter 6 Storage in Carrying Case

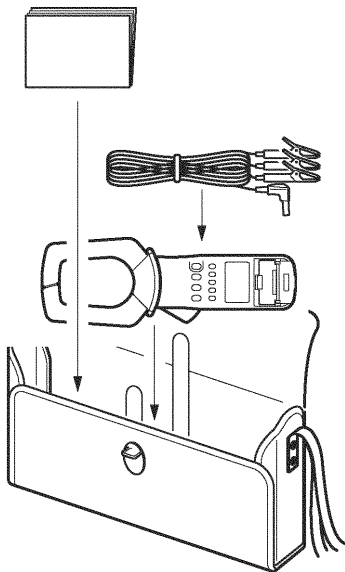

Store all instruments in the carrying case, then secure it with the band.



Chapter 7

Troubleshooting

If the instrument seems not to be working normally, check the following points first before requesting service.

Symptom	Battery	Battery clip	Voltage cord
Instrument does not come on.	Yes	Yes	
 indication appears and instrument immediately turns off.	Yes		
 indication appears.	Yes		
Instrument turns off during use.*	Yes	Yes	
Voltage cannot be measured.			Yes
Remedy: If problem persists, request service.	Replace battery.	Check connection of battery to clip.	Check voltage cord for broken wire. Check the voltage cord to make sure the root of the clip is connected to the banana plug firmly.

NOTE

* When APS (auto power-off) is effective, the instrument is automatically shut down when no key is pressed for about 10 minutes. (See 2.11, "Auto Power-Off Function.")

Symptom	Confirmation item. and etc.
Cannot be measured. "----" will be displayed. Becomes fixed.	(1 ϕ PF meter, 3 ϕ PF meter) Confirm the direction of the clamp sensor, and connections of the voltage cord. (Frequency measurement) Check the waveform. Some special frequencies can't be measured, such as those of inverters. Check that the input value corresponds to 1 A or less and 10 V or less.
The desirable measurement data aren't taken. (The measured value is smaller or larger than the estimated value.	(1 ϕ P meter, 1 ϕ PF meter, 3 ϕ PF meter) Confirm the direction of the clamp sensor, and Connections of the voltage cord. Check that the clamp sensor is firmly closed. Check that the battery warning annunciator  is off.
The display fluctuates largely at the peak display.	There is a possibility to fluctuate 2 or 20 counts when the input becomes big.
If the cause cannot be determined after troubleshooting, reset to their initial values. To reset, hold down the RANGE key at instrument power-on. The entire LCD will go on, and "ALL CLR" will appear. This resets the saved contents to their initial values.	

Symptom	Treatment
An indication Err1 to Err5 appears.	Send the instrument for repair.

Chapter 8 Service

- To clean the instrument, wipe it gently with a soft cloth moistened with water or mild detergent. Never use solvents such as benzene, alcohol, acetone, ether, ketones, thinners or gasoline, as they can deform and discolor the case.
- The minimum stocking period for replacement parts is five years after end of production.
- If damage is suspected, check the "Troubleshooting" section before contacting your dealer or HIOKI representative.
- For information regarding service, please contact your dealer or the nearest HIOKI representative.
- When sending the instrument for repair, pack the instrument so that it will not sustain damage during shipping, and include a description of existing damage. We cannot accept responsibility for damage incurred during shipping.

Warranty Certificate

Model	Serial No.	Warranty period
		One (1) year from date of purchase (___ / ___)

This product passed a rigorous inspection process at Hioki before being shipped.

In the unlikely event that you experience an issue during use, please contact the distributor from which you purchased the product, which will be repaired free of charge subject to the provisions of this Warranty Certificate. This warranty is valid for a period of one (1) year from the date of purchase. If the date of purchase is unknown, the warranty is considered valid for a period of one (1) year from the product's date of manufacture.

Please present this Warranty Certificate when contacting the distributor.

Accuracy is guaranteed for the duration of the separately indicated guaranteed accuracy period.

1. Malfunctions occurring during the warranty period under conditions of normal use in conformity with the Instruction Manual, product labeling (including stamped markings), and other precautionary information will be repaired free of charge, up to the original purchase price. Hioki reserves the right to decline to offer repair, calibration, and other services for reasons that include, but are not limited to, passage of time since the product's manufacture, discontinuation of production of parts, or unforeseen circumstances.
2. Malfunctions that are determined by Hioki to have occurred under one or more of the following conditions are considered to be outside the scope of warranty coverage, even if the event in question occurs during the warranty period:
 - a. Damage to objects under measurement or other secondary or tertiary damage caused by use of the product or its measurement results
 - b. Malfunctions caused by improper handling or use of the product in a manner that does not conform with the provisions of the Instruction Manual
 - c. Malfunctions or damage caused by repair, adjustment, or modification of the product by a company, organization, or individual not approved by Hioki
 - d. Consumption of product parts, including as described in the Instruction Manual
 - e. Malfunctions or damage caused by transport, dropping, or other handling of the product after purchase
 - f. Changes in the product's appearance (scratches on its enclosure, etc.)
 - g. Malfunctions or damage caused by fire, wind or flood damage, earthquakes, lightning, power supply anomalies (including voltage, frequency, etc.), war or civil disturbances, radioactive contamination, or other acts of God
 - h. Damage caused by connecting the product to a network
 - i. Failure to present this Warranty Certificate
 - j. Failure to notify Hioki in advance if used in special embedded applications (space equipment, aviation equipment, nuclear power equipment, life-critical medical equipment or vehicle control equipment, etc.)
 - k. Other malfunctions for which Hioki is not deemed to be responsible

***Requests**

- Hioki is not able to reissue this Warranty Certificate, so please store it carefully.
- Please fill in the model, serial number, and date of purchase on this form.

13-09

HIOKI E.E. CORPORATION

81 Koizumi, Ueda, Nagano 386-1192, Japan
TEL: +81-268-28-0555
FAX: +81-268-28-0559

- Please visit our website at www.hioki.com for the following:
 - Regional contact information
 - The latest revisions of instruction manuals and manuals in other languages.
 - Declarations of Conformity for instruments that comply with CE mark requirements.
- All reasonable care has been taken in the production of this manual, but if you find any points which are unclear or in error, please contact your supplier or the International Sales and Marketing Department at Hioki headquarters.
- In the interests of product development, the contents of this manual are subject to revision without prior notice.
- The content of this manual is protected by copyright.
No reproduction, duplication or modification of the content is permitted without the authorization of Hioki E.E. Corporation.

HIOKI

HIOKI E. E. CORPORATION

HEADQUARTERS

81 Koizumi, Ueda, Nagano 386-1192, Japan
TEL +81-268-28-0562 FAX +81-268-28-0568
os-com@hioki.co.jp
(International Sales Department)

www.hioki.com

HIOKI USA CORPORATION

hioki@hiokiusa.com www.hiokiusa.com

HIOKI (Shanghai) SALES & TRADING CO., LTD.

info@hioki.com.cn www.hioki.cn

HIOKI INDIA PRIVATE LIMITED

hioki@hioki.in www.hioki.in

HIOKI SINGAPORE PTE. LTD.

info@hioki.com.sg

1502EN